

Plastic resin is fully FDA compliant based upon manufacturer's specifications

Resins are fully UV stabilized

Allow +/- 1% on dimensions for overall size variances

REVISION HISTORY

REV	DESCRIPTION	DATE	APPROVED

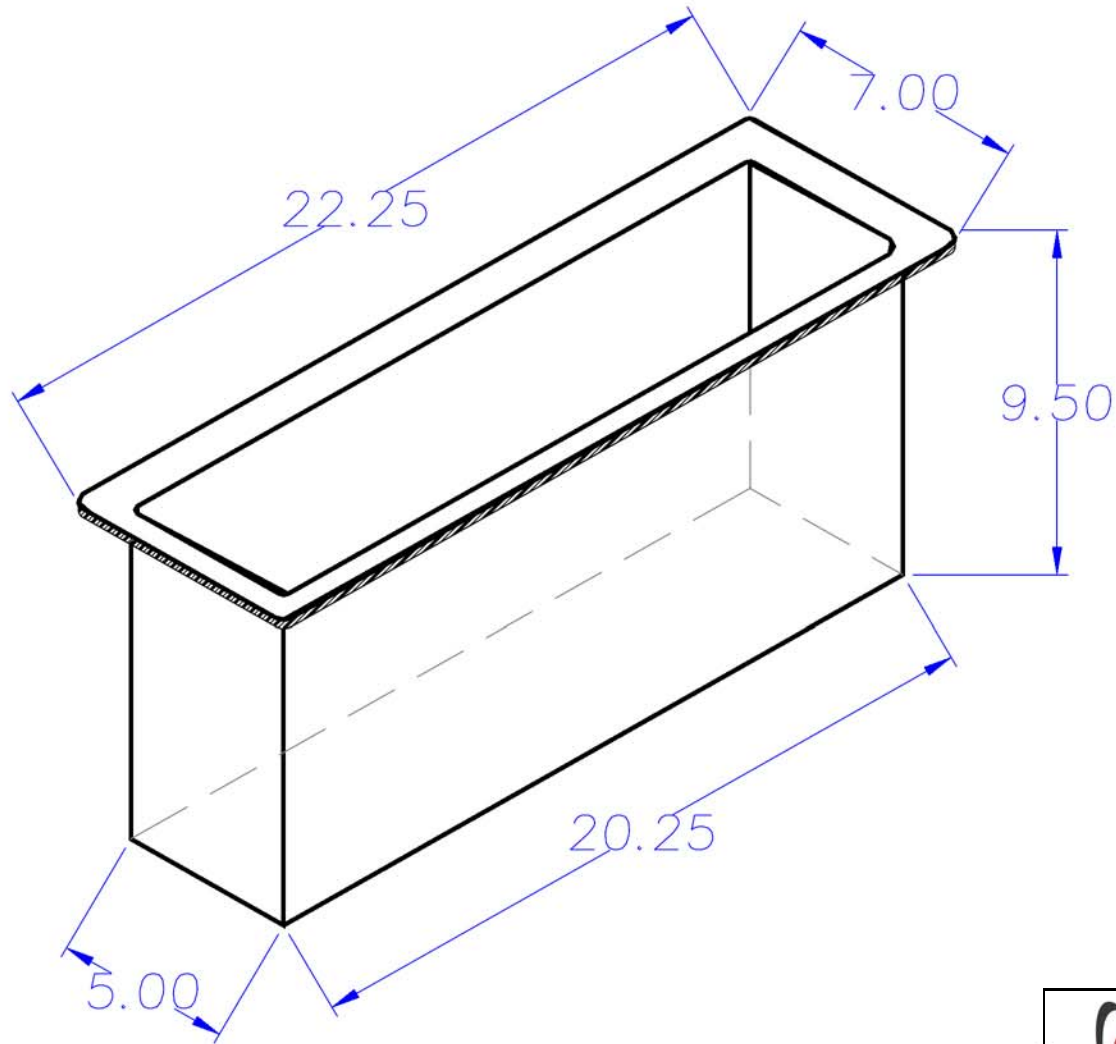

Capacity: 4 Gallons		
	NAME	DATE
DRAWN	MPUTT	9/01/2004
CHECKED		
ENG APPR		
MGR APPR		

Dura-Cast Products INC.
Rotomolding Plastic for the Future
 16160 Hwy 27 Lake Wales, FL 33859
 800.683.4116 863.638.3200 F 863.638.2443
 www.duracast.com

TITLE Bin		
SIZE A	MATERIAL: LMDPE Natural	REV

Part #: 103901		
WEIGHT: 4#	SHEET 1 OF 1	

Wall Thickness: 0.125

UNLESS OTHERWISE SPECIFIED
 DIMENSIONS ARE IN INCHES
 ANGLES ±0.5°
 2 PL ±0.125° 3 PL ±0.060°